

AXE 超薄型溫度隔離傳送器

(SSTMT操作手冊)

[各部名稱]

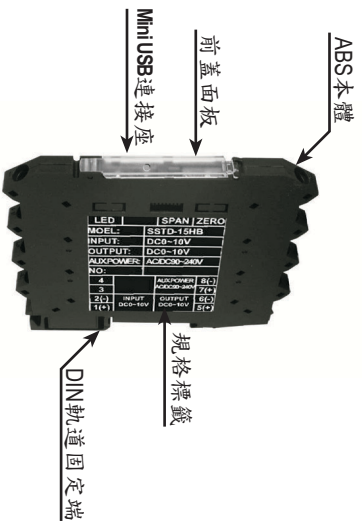

[接線圖]

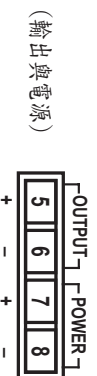

(輸出與電源)

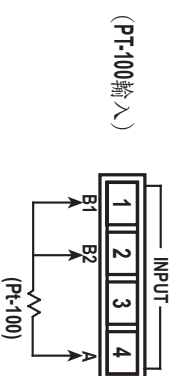

(Pt-100輸入)

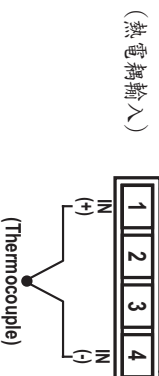

(熱電偶輸入)

[外型尺寸圖]

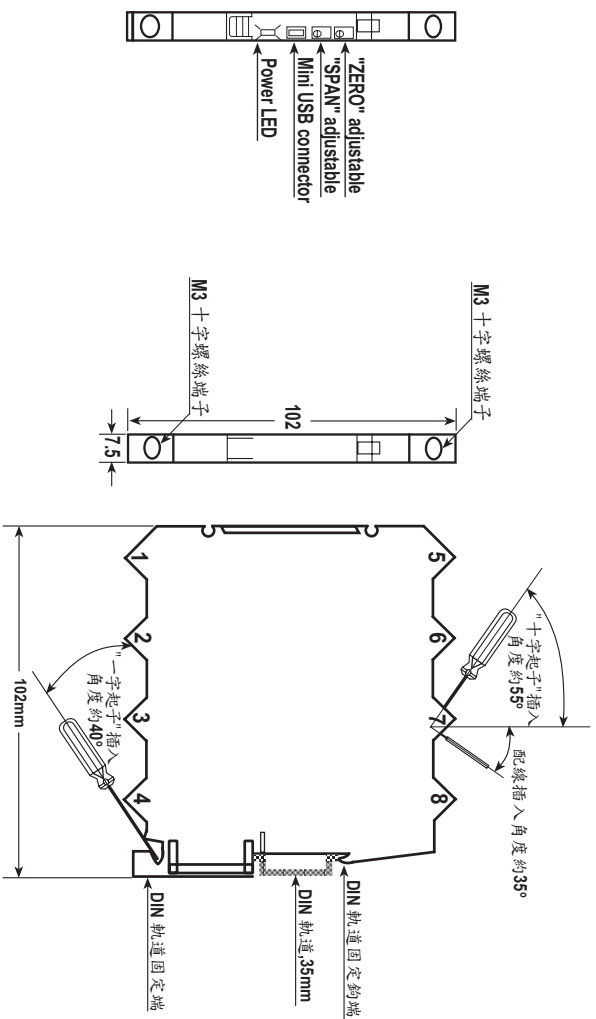

[安裝方式]

- 固定傳送器至軌道程序
- 請把傳送器之DIN軌道固定端置於下方
- A:把軌道固定鉤端,置入於DIN軌道上
- B:輕壓傳送器低端,直到傳送器置入於DIN軌道

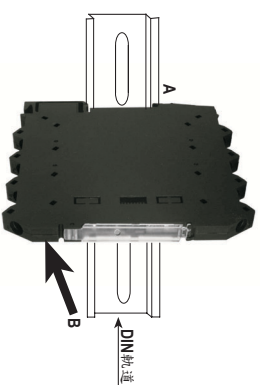

- 移開傳送器從DIN軌道程序
- A:把"一字起子"插入DIN軌道固定端,向A-1方向移動
- B:同時將傳送器低端向上抬起,使傳送器之DIN軌道固定端離開DIN軌道
- C:讓傳送器之DIN軌道固定鉤端,離開DIN軌道

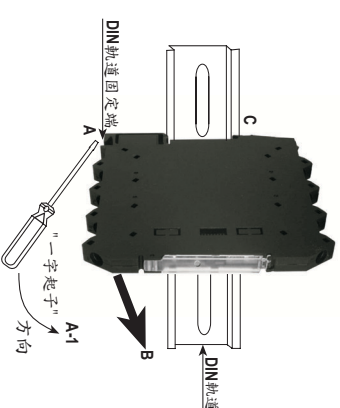

[輸出開關TABLE]

開關狀態: 1=ON, 0=OFF

Output range	1-2-3-4-5-6	7-8
0-0.5V	0-1-1-1-1-0	1-1
0-1V	1-0-1-1-1-0	1-1
0-2V	1-1-0-1-1-0	1-1
0-4V	1-1-1-0-1-0	1-1
0-5V	1-0-1-0-1-0	1-1
1-5V	1-1-1-0-1-1	1-1
0-6V	1-1-0-0-1-0	1-1
0-8V	1-1-1-1-0-0	1-1
0-10V	1-1-0-1-0-0	1-1
2-10V	1-1-1-1-0-1	1-1
0-1mA	0-1-1-1-1-0	0-0
0-2mA	1-0-1-1-1-0	0-0
0-5mA	0-1-0-1-1-0	0-0
1-5mA	1-1-0-1-1-1	0-0
0-10mA	1-1-1-0-1-0	0-0
2-10mA	1-1-1-1-0-1	0-0
0-16mA	1-1-1-1-0-0	0-0
0-20mA	1-1-0-1-0-0	0-0
4-20mA	1-1-1-1-0-1	0-0

